

World's 1st

FURUNO®

10.4" Color TFT LCD and Black Box Configurations
DUAL FREQUENCY SEARCHLIGHT SONAR
Model CH-300

- Incorporates both a low and a high frequency (60/153 or 85/215 kHz) transducer in one soundome
- BlackBox system configuration allows use of FURUNO or commercial monitors
- CUSTOM MODE keys provide one-touch setup or short-cut key function
- Variety of display modes: Horizontal and Vertical scan, Mix, Echo sounder
- Compact hull unit for space saving installation (select from 250 or 400 mm travel)
- Pulse length automatically switched according to range selected, to optimize performance
- Target lock tracks selected fish schools or L/L position
- Multi language menu: English, Spanish, Danish, Portuguese, French, Norwegian, Italian, Swedish and Thai

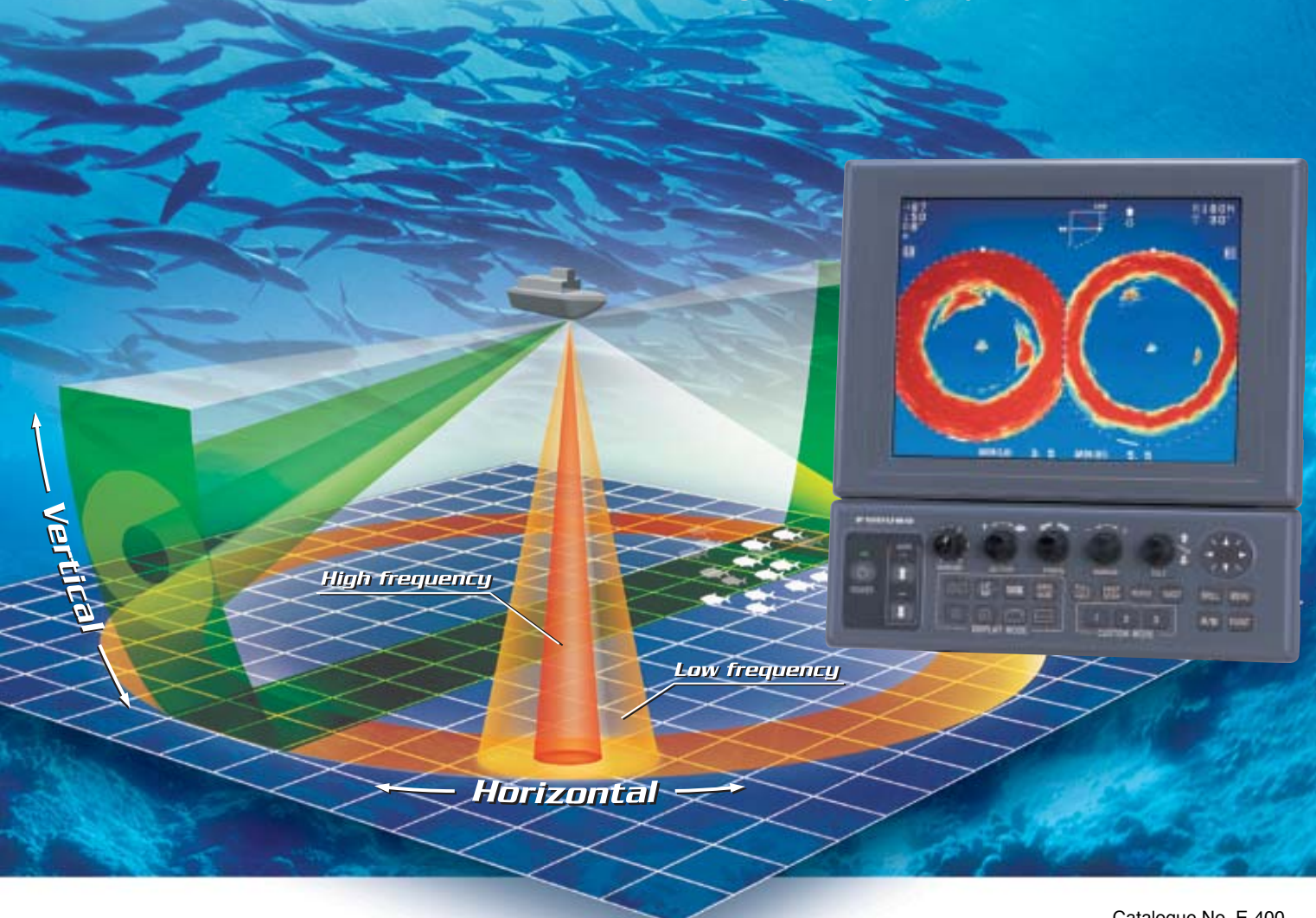

The future today with FURUNO's electronics technology.

FURUNO ELECTRIC CO., LTD.

9-52 Ashihara-cho, Nishinomiya City, Japan Telephone: +81 (0)798 65-2111
Telefax: +81 (0)798 65-4200, 66-4622 URL: www.furuno.co.jp

Catalogue No. E-400

TRADE MARK REGISTERED
MARCA REGISTRADA

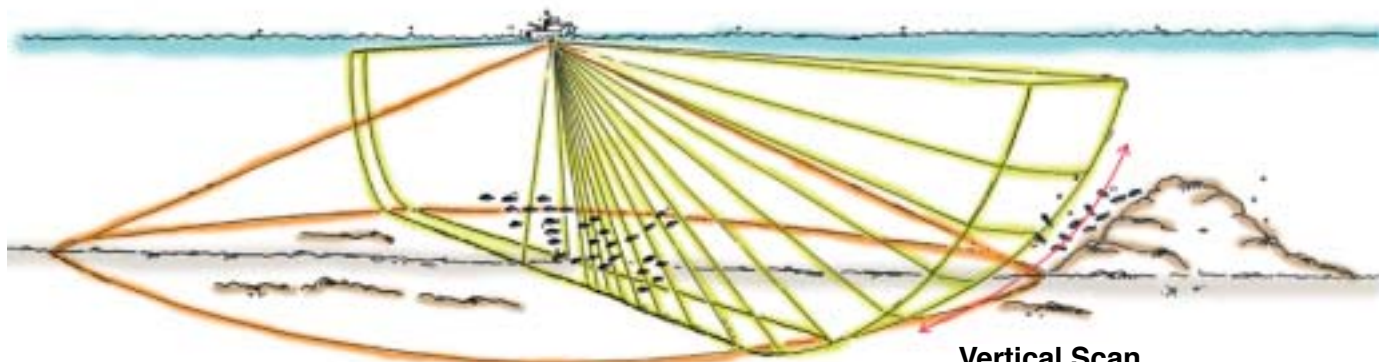

Horizontal Scan

Vertical Scan

The world's first dual-frequency searchlight sonar CH-300 is designed for a wide range of commercial or sport fishing vessels. Its operating frequency can be selected from either 60/153 or 85/215 kHz, and the transducers are incorporated in one soundome. The high frequency of, 153 and 215 kHz, gives a highly detailed search near and all around the vessel. The lower frequency, 60 and 85 kHz, enables long-range searches of over 500 m. With advantages of both high and low frequency, the CH-300 helps to search on a rough seabed and to greatly enhance fish school detection.







A variety of presentation modes are available: horizontal and vertical scan, echo sounder and the combination mode displaying horizontal and vertical scan/historical/plotter presentations. The combination of horizontal and vertical scan helps evaluate the distribution of fish schools in both the horizontal and vertical planes simultaneously.

The CH-300's unique mix mode uses the frequency characteristic that "high frequency beams receive stronger echoes from tiny fish, compared with low

frequency". By comparing the returned echo intensity of both frequencies, this mode picks out the echoes of tiny fish and displays them in discriminative colors. Other echoes are displayed in the weakest color. This helps to discriminate tiny fish such as small bait fish from other fish.

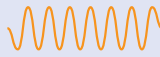
The CH-300 provides two target lock modes to track a fish echo and stationary position such as a fish shelter or reef. Target Lock automatically tracks the chosen fish school. In Position Track, the beam is locked onto the L/L position specified by the target marker.

Standard package consists of a 10.4" LCD, control, transceiver and compact hull units. This separated system configuration provides a flexible and space-saving installation. A BlackBox configuration (without monitor) is also available. The hull unit, whose travel or stroke can be selected at either 250 mm or 400 mm, will fit any boat where a 190 mm (7.5") internal diameter hull tube is available. Also, a previously installed CH-250 can be changed to the CH-300 without dry-docking since both models use the same size hull unit.

	Long-range detection	Use in shallow waters	Wide-area detection	Detection of bottom fish	Detection of bait fish	Affected by cavitation from other vessel
Low frequency  featuring a wide beamwidth	 Attenuation loss is small		 Detection area is wide, so detection deadspots are reduced			
High frequency  featuring a narrow beamwidth		 Bottom echo is less prominent because of narrow beam width		 Fish and bottom echoes are displayed separately	 Bait fish are more easily detected	 Strong echoes from other ship's cavitation trail



Stabilizer: ON
the beam on the targeted fish.



Stabilizer: OFF
The beam, affected by pitching and rolling, fails to detect the targeted fish.

Beam stabilization
Even in rough seas, the sonar beam is kept at the required tilt angle by using ship's pitch and roll information. The CH-300 can obtain this information from a satellite compass (SC-50/110). The motion sensor MS-100 or clinometer BS-704 can also be interfaced.

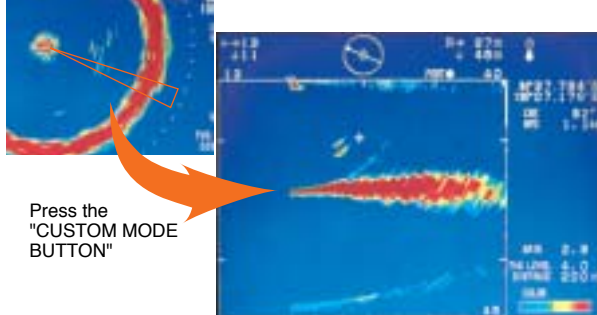

Press the "CUSTOM MODE BUTTON"

Cross section scan
The CH-300 has a "Cross Section Scan" function. It allows you to instantly view the vertical plane in a specific direction by pressing the "CUSTOM MODE BUTTON". It is useful for evaluating the concentration and location of the targeted fish school as well as for navigation purposes.

Compact soundome contains a dual-frequency transducer. See fish targets you have never seen before!

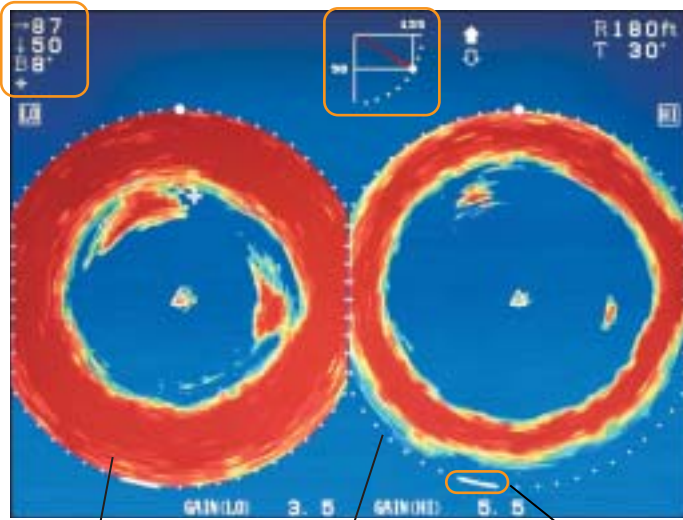

Low frequency High frequency Sweep indicator (Shows train position)

Horizontal scan

The horizontal scan helps detect fish schools at any tilt, all around the vessel. In the dual-frequency presentation, any two presentations from high/low frequency scan and the mix mode can be displayed. Gain of each mode can be adjusted separately.

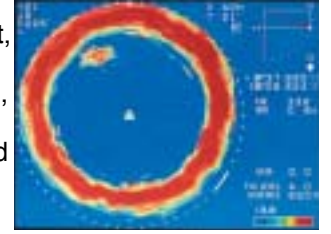

Cursor position data
 →: Horizontal range
 ↓: Depth
 B: Bearing



Tilt angle indicator
 1: Horizontal max. range
 2: Vertical max. depth
 3: Tilt angle

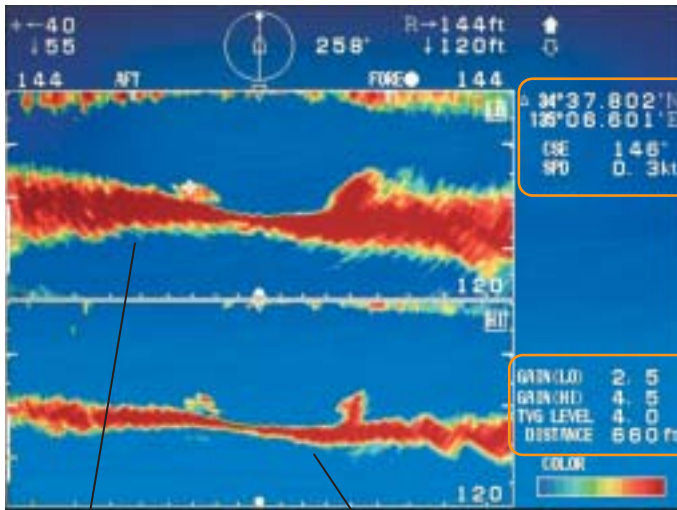

Low frequency High frequency

Vertical scan

The vertical scan paints the bottom profile within a user-specified vertical plane in any direction. In the dual-frequency presentation, the vertical scan mode shows any two of high/low frequency scan and the mix mode. The slant range and sonar dome tilt are graphically shown by a cursor indicator.

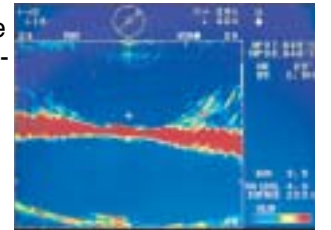

Nav data (Requires appropriate sensor)
 •Position in latitude, longitude
 •Course
 •Speed

Echo settings
 •Gain setting
 •TVG level
 •Distance settings

Horizontal with vertical scan

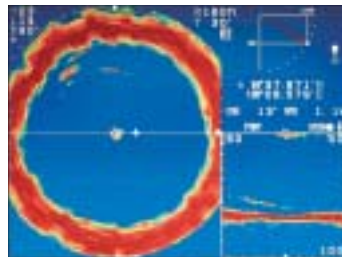

Half-circle horizontal with vertical scan

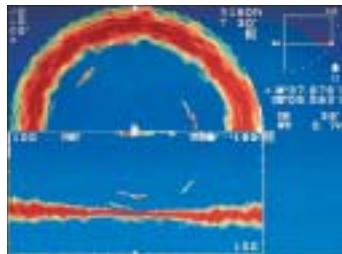

Combination of horizontal with vertical scan

A unique feature of this sonar is a mode integrating the two images above. This sonar image can be switched between full and half circle with vertical scan.

Echo sounder

The transducer tilted down at 90 degrees can sound fish schools and seabed straight down like a fish finder. This mode is available when the soundome is retracted into the tank.

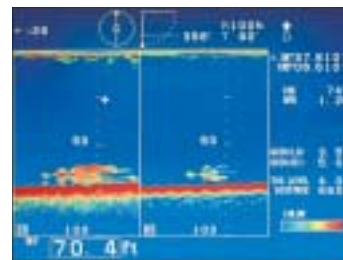

Horizontal scan with VideoPlotter

Own ship track is displayed on the sonar image, which is ideal for purse seining or bottom trawling.



VideoPlotter display(sub window)
 1: Track
 2: Sonar range marker (Radius changes with video plotter range)
 3: Scale

SPECIFICATIONS OF CH-300

1. Display Unit

Standard: 10.4" TFT color LCD
 BlackBox: FURUNO 15" LCD MU-151C/155C and 12.1" LCD MU-120C, recommended or commercial monitor (640 x 480 pixels)

2. Color

Echo: 16 or 8 colors (echo)
 Background: 3 colors selected (user setting available)

3. Display Mode

Horizontal scan (Normal/Expanded), Vertical scan, Mix, Echo sounder

4. Combination Display

Plotter, Vertical scan, History

5. External Data Indication

L/L, Depth, Course, Ship's speed, Water current vector, Track, Water temperature (External IEC 61162 data required)

6. Audio Monitor

1000 Hz

7. TX Output Power

1 kW

8. Frequencies

60/153 or 85/215 kHz

9. Beamwidth (at -3 dB)

60/153 kHz: 16°/7° (Hor), 14°/5° (Ver)
 85/215 kHz: 11°/5° (Hor), 10°/4° (Ver)

10. Transducer Control

Tilt: 0° to -180° at 3° or 6° steps (Ver)
 +5° to -90° at 1° steps (Hor)

Training Sector: Manual or automatic training at 6° or 12° steps in search sector 6° to 360°
 By L/L, Echo position

Target Lock:

11. Range scales (Feet, Fathom, Passi/Braza can be selected)

Horizontal: 15 ranges customized between 10 to 1600 m
 Vertical: 15 ranges customized between 10 to 600 m

12. Interface (NMEA 0183 Ver 1.5, 2.0, IEC 61162-1)

Input: DBS, DBT, DPT, GGA, GLL, HDG, HDM, HDT, MDA, MTW, RMA, RMC, VDR, VHW, VTG, att
 Output: TLL

13. Language

English, Spanish, Danish, Portuguese, French, Norwegian, Italian, Swedish, Thai

POWER SUPPLY

Transceiver Unit: 12-24 VDC; 7.0-3.5 A
 Hull Unit: 12/24 VDC; 4.7/2.3 A, 16.7/8.2 A*
 *While raising/lowering transducer

ENVIRONMENT

Temperature
 Display, Transceiver Unit: -15°C to +55°C
 Hull Unit: 0°C to +35°C
 Waterproofing
 Display Unit: IEC IPX5
 Hull Unit: IEC IPX2

EQUIPMENT LIST

Standard

- | | |
|--|--------|
| 1. Display Unit MU-100C (Not included in BlackBox) | 1 unit |
| 2. Control Unit CH-302 | 1 unit |
| 3. Transceiver Unit CH-303 | 1 unit |
| 4. Hull Unit | 1 unit |
| CH-304 (travel 400 mm) or CH-305 (travel 250 mm) | |
| 5. Interface Unit IF-8000 (BlackBox only) | 1 unit |
| 6. Installation Materials and Spare Parts | 1 set |

Option

- | |
|--|
| 1. Remote Controller CH-256-E |
| 2. Rectifier RU-1746B-2 |
| 3. Loudspeaker SC-05WR, Horn |
| 4. Transducer Tank |
| Steel: 1, 1.8, 3.5 m; FRP: 1, 1.8 m; Aluminum: 1 m |
| 5. NMEA Cable |
| 6P-6P: 5 m (MJ-A6SPF0012-050), 10 m (MJ-A6SPF0012-100) |
| 6P-4P: 5 m (MJ-A6SPF0011-050), 10 m (MJ-A6SPF0011-100) |
| 6. Motion Sensor MS-100 |
| 7. Clinometer BS-704 |
| 8. Interface Unit IF-8000 |

Interconnection Diagram

Display Unit

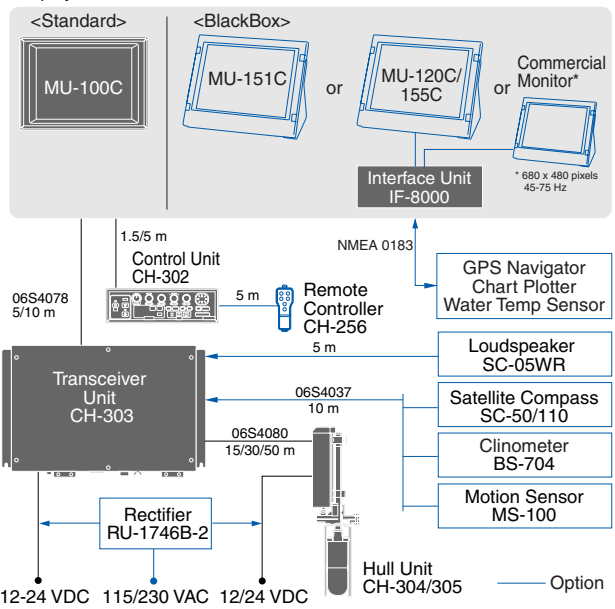

Display and Control Unit

MU-100C and CH-302

5.7 kg, 12.6 lb

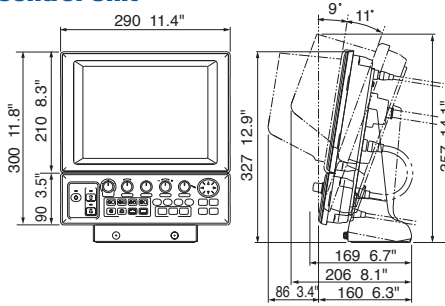

Flush mount type
 4.2 kg, 9.3 lb

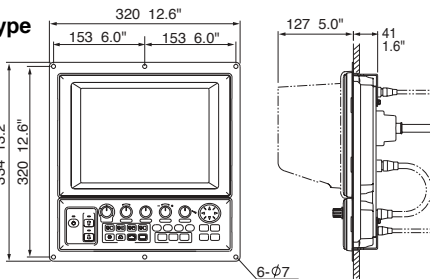

Transceiver Unit

CH-303 3.5 kg, 7.7 lb

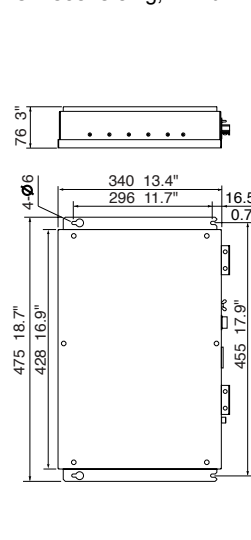

Hull Unit

CH-304 (Travel 400 mm)
 43 kg, 94.8 lb
CH-305 (Travel 250 mm)
 42 kg, 92.6 lb

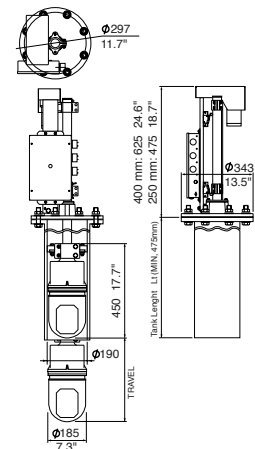

SPECIFICATIONS SUBJECT TO CHANGE WITHOUT NOTICE

FURUNO U.S.A., INC.
 Camas, Washington, U.S.A.
 Phone: +1 360-834-9300
 Fax: +1 360-834-9400

FURUNO (UK) LIMITED
 Denmead, Hampshire, U.K.
 Phone: +44 2392-230303
 Fax: +44 2392-230101

FURUNO FRANCE S.A.
 Bordeaux-Mérignac, France
 Phone: +33 5 56 13 48 00
 Fax: +33 5 56 13 48 01

FURUNO ESPAÑA S.A.
 Madrid, Spain
 Phone: +34 91-725-90-88
 Fax: +34 91-725-98-97

FURUNO DANMARK AS
 Hvidovre, Denmark
 Phone: +45 36 77 45 00
 Fax: +45 36 77 45 01

FURUNO NORGE A/S
 Ålesund, Norway
 Phone: +47 70 102950
 Fax: +47 70 127021

FURUNO SVERIGE AB
 Västra Frölunda, Sweden
 Phone: +46 31-7098940
 Fax: +46 31-497093

FURUNO FINLAND OY
 Espoo, Finland
 Phone: +358 9 4355 670
 Fax: +358 9 4355 6710

FURUNO POLSKA Sp. Z o.o.
 Gdynia, Poland
 Phone: +48 58 669 02 20
 Fax: +48 58 669 02 21



05045Y Printed in Japan